



BASEN GREEN



Fax: (+86)0755-84737145

Tel: (+86)130 0887 9993

Email: info@basen-power.com

Website: www.basenpower.com

Shenzhen Basen Technology Co., Ltd.

Add: Room 303, Building 3, 1980 Culture and Technology Industrial Park,
Donghuan Road, Longhua District, Shenzhen



Website



YouTube



LinkedIn



Facebook

ENERGY STORAGE SOLUTION PROVIDER

CONTENTS

BASEN GREEN



01

01 About us

- 03 History
- 04 Partnership Models
- 05 Global Partners

02

07 Residential ESS

- 09 Wall-Mounted Series
- 13 Wall/Floor-Mounted Series
- 17 Rack-Mounted Series
- 21 Push-Pull Cooling Series
- 23 Stackable Series

03

25 Commercial ESS

- 27 Rack-Mounted Series
- 29 Stackable Series
- 33 C&I ESS

04

37 Outdoor Energy Storage

- 39 RV Battery Series
- 47 Golf Cart Battery Series
- 49 Portable Power Station

05

51 DIY Energy Storage Kit

- 51 12V/24V DIY Kit
- 48V DIY Kit

06

53 Explore

- 53 Company Honors
- 55 Projects

ABOUT US

Basengreen is a global provider of advanced energy storage solutions, specializing in lithium iron phosphate (LiFePO₄) battery packs and integrated systems for residential, commercial, and industrial applications.

With over 12 years of experience in the energy sector, we focus on innovation, performance, and long-term reliability. Our solutions support renewable energy integration, grid stabilization, peak shaving, backup power, and microgrid deployment.

Operating in more than 100 countries, Basengreen offers fast delivery through overseas warehouses and supports OEM/ODM customization for global partners. Our products are certified by TUV, IEC, CE, UKCA, and RoHS, meeting international standards of safety and quality.

At Basengreen, we are committed to powering a sustainable future with honest service, global vision, and deep customer collaboration.

2GWH

Annual Production Capacity

12000

Factory's sqm

1000+

Global Customer

138+

Countries Covered



Innovation

Excellence

Trust

Sustainability

HISTORY

Energy storage solution provider

OUR HISTORY

2013



Company establishment

2014-2015

Engaged in lithium battery product trading.

2016

Passed key international certifications: CE, UN38.3, RoHS, and IEC.



Launched the BASEN brand, offering batteries and related energy products.

2017

2019

Established own manufacturing facility



2020

Launched the Basengreen brand and established overseas warehouses in Poland and the USA, marking the start of global expansion.

2021-2023

Developed a full line of Basengreen energy storage products; expanded in Europe and set up a warehouse in Germany.

2024

Achieved TÜV IEC product certification and obtained High-Tech Enterprise Certification

2025

Expanded Middle East presence with a sales office in Iraq and a new partnership in Yemen, and launched the second manufacturing facility.

Iraq sales office X1

Manufacturing facility X2

Iraq warehouses X2

Yemen sales center X1

Poland warehouse X1

USA warehouse X1



PARTNERSHIP MODELS



Brand & OEM/ODM Support

We focus on building our own strong Basengreen brand while offering flexible OEM and ODM services to tailor products to your specific needs. Whether you want to carry our brand or customize solutions under your own label, we provide full support from design to production.



Exclusive Distribution Rights

Grant exclusive rights to distribute Basengreen products within designated regions, ensuring dedicated market presence and focused brand growth.



Inventory & Logistics Support

Provide stock and logistical support based on partnership level, ensuring continuous product availability and efficient delivery.



Marketing & Sales Enablement

Support your market expansion with marketing materials, product training, and sales strategy assistance to maximize your performance.



Non-exclusive Cooperation

Offer flexible partnership options allowing the sale of non-competing brands alongside Basengreen, ideal for diversified portfolios.

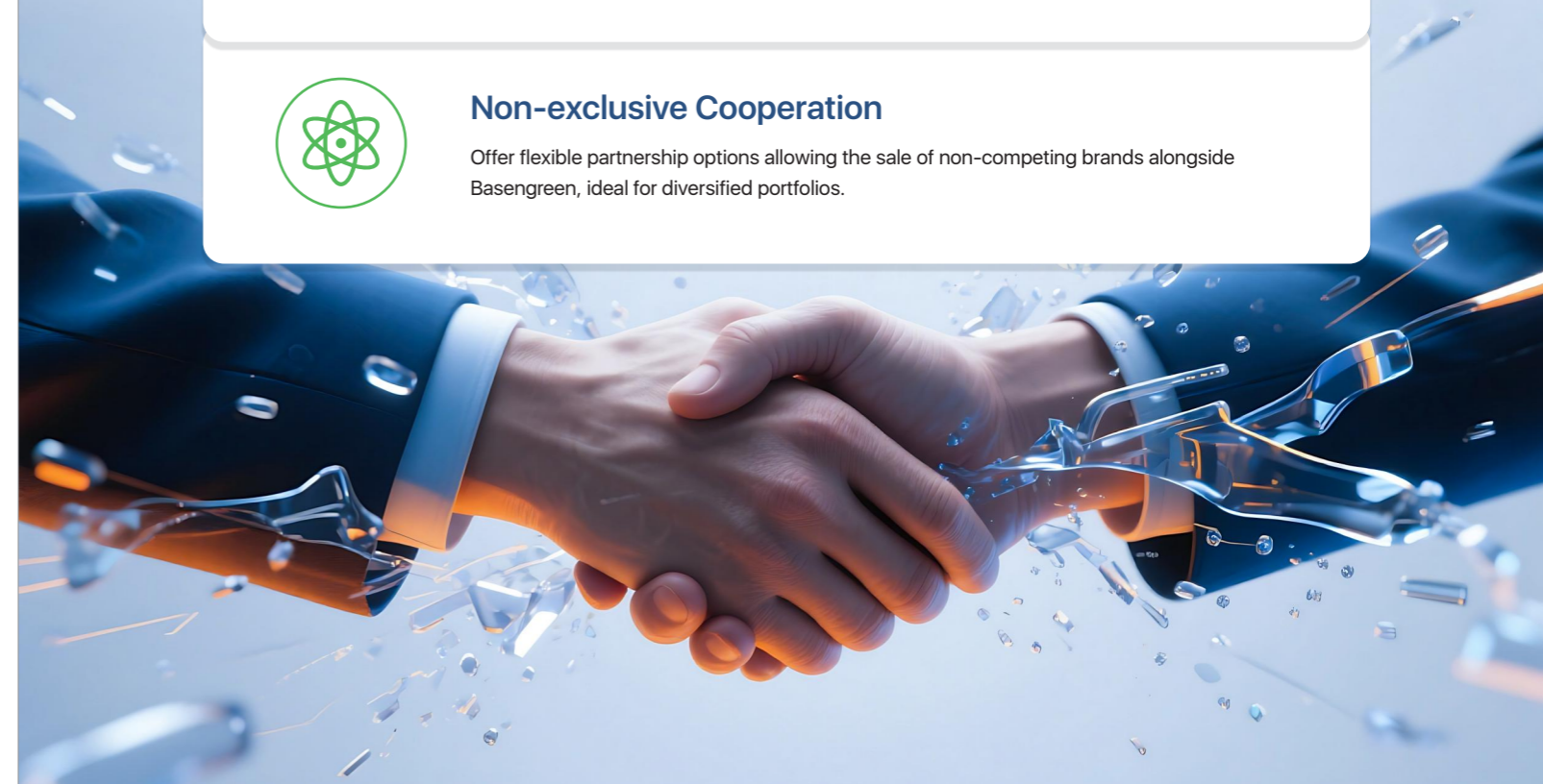

GLOBAL PARTNERS

BASEN GLOBAL SERVICE CENTER

Global Key Partners



OUR PARTNERS

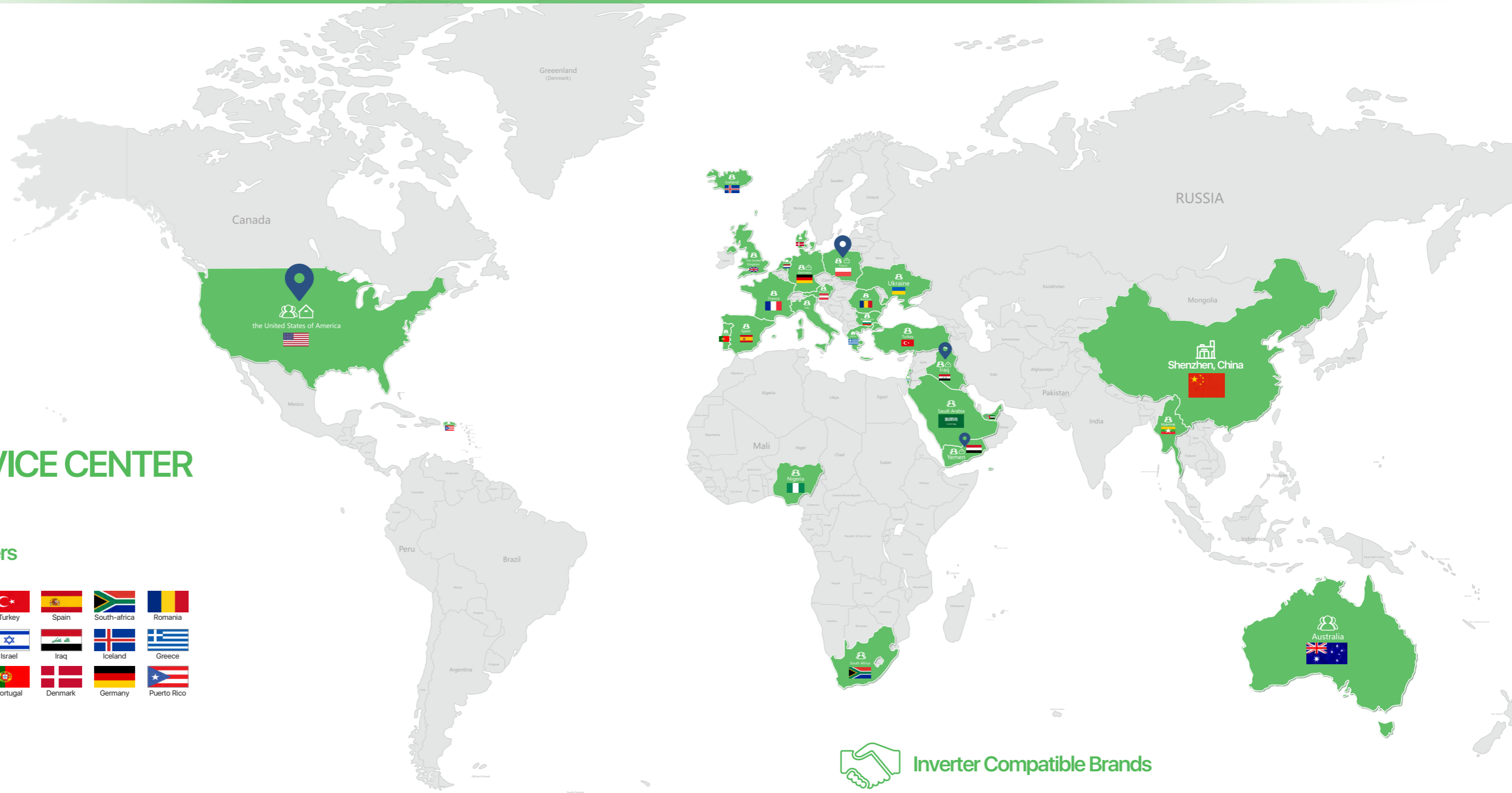

Inverter Compatible Brands



25.6V/51.2V
WALL-MOUNTED
LIFEPO4 SERIES



51.2V WALL/FLOOR
-MOUNTED
LIFEPO4 SERIES



51.2V
FLOOR-MOUNTED
LIFEPO4 SERIES



51.2V
RACK-MOUNTED
LIFEPO4 SERIES



51.2V PUSH-PULL
COOLING MODEL
SERIES



51.2V STACK
LIFEPO4 SERIES



25.6V WALL-MOUNTED LIFEPO4 SERIES

BR-WM-LV 2.5KWH(8S)

BR-WM-LV 5.8KWH(8S)

BR-WM-LV 7.6KWH(8S)

BR-WM-LV 8KWH(8S)



PRODUCT FEATURES



Advanced LiFePO4 Technology
Lithium iron phosphate(LFP) Battery, longer cycle life, stable performance



Advanced Protection
BasenGreen Smart BMS & Protective Circuit Breaker Reliable protection against electric fault



Multi-language Support
Touch screen, easy to operate, supports multiple languages



Reliable Power
Up to 15 years service life



Flexible Configuration
Support up to 16 units in parallel



APP Monitoring
Real-time monitor from Bluetooth & Wi-Fi

OEM/CUSTOMIZED OPTIONS



Heating



Cooling Fan



Fire Protection



Touch Screen



Active Balancer



Magnetic cover







Model	BR-WM-LV 2.5KWH(8S)	BR-WM-LV 5.8KWH(8S)	BR-WM-LV 7.6KWH(8S)	BR-WM-LV 8KWH(8S)
Battery Chemistry	Lithium iron phosphate(LiFePO4)			
Rated Voltage(V)	25.6			
Operating Voltage Range(V)	21.6-28.8			
Charge/Discharge Cut-off Voltage(V)	29.2/21.6			
Capacity(Ah)	100	230	300	314
Energy(Wh)	2560	5888	7680	8038
Cycle Life	6000 Cycles (@80% DoD, 25°C/0.5C)	6000 Cycles (@80% DoD, 25°C/0.5C)	8000 Cycles (@80% DoD, 25°C/0.5C)	8000 Cycles (@80% DoD, 25°C/0.5C)
Max. CHG/DSCHG Current(A)	100	200	200	200
Dimension(L*W*H,mm)	480*335*197	480*470*267	550*500*267	550*500*267
Weight Approximate(kg)	30	53	65	66
Communication Port	RS485, CAN, RS232			
Parallet Connection	Up to 16 units in parallel			
Protection Level	IP55			
Charge Temperature Range	0°C~60°C			
Discharge Temperature Range	-20°C~60°C(Under 0°C work with reduced capacity)			
Storage Temperature Range	-40°C~55°C @ 60±25% relative humidity			
Inverter Compatibility	DEYE, Victron, Growatt, Solis, Sofar, Goodwe, etc			
Optional Feature	Heating, Cooling Fan, Active Balancer, Touch Screen, Fire Protection			
Warranty	10 Years (warranty or cycle life, whichever comes first)			

51.2V WALL-MOUNTED LIFEPO4 SERIES

- BR-WM-LV 5KWH
- BR-WM-LV 6KWH
- BR-WM-LV 7.6KWH
- BR-WM-LV 10KWH









PRODUCT FEATURES

 <p>Advanced LiFePO4 Technology Lithium iron phosphate(LFP) Battery, longer cycle life, stable performance</p>	 <p>Advanced Protection BasenGreen Smart BMS & Protective Circuit Breaker Reliable protection against electric fault</p>	 <p>Multi-language Support Touch screen, easy to operate, supports multiple languages</p>
 <p>Reliable Power Up to 15 years service life</p>	 <p>Flexible Configuration Support up to 16 units in parallel</p>	 <p>APP Monitoring Real-time monitor from Bluetooth & Wi-Fi</p>

Model	BR-WM-LV 5KWH	BR-WM-LV 6KWH	BR-WM-LV 7.6KWH	BR-WM-LV 10KWH
Battery Chemistry	Lithium iron phosphate(LiFePO4)			
Rated Voltage(V)	51.2			
Operating Voltage Range(V)	43.2-57.6			
Charge/Discharge Cut-off Voltage(V)	58.4/43.2			
Capacity(Ah)	100	125	150	200
Energy(Wh)	5120	6144	7680	10240
Cycle Life	6000 Cycles (@80% DoD, 25°C/0.5C)	6000 Cycles (@80% DoD, 25°C/0.5C)	6000 Cycles (@80% DoD, 25°C/0.5C)	6000 cycles (@80% DoD, 25°C/0.5C)
Max. CHG/DSCHG Current(A)	100	100	100	100
Dimension(L*W*H,mm)	580*480*227	530*450*242	600*440*262	630*510*272
Weight Approximate(kg)	50	55	68	94
Communication Port	RS485, CAN			
Parallet Connection	Up to 16 units in parallel			
Protection Level	IP55			
Charge Temperature Range	0°C~60°C			
Discharge Temperature Range	-20°C~60°C(Under 0°C work with reduced capacity)			
Storage Temperature Range	-40°C~55°C @ 60±25% relative humidity			
Inverter Compatibility	DEYE, Victron, Growatt, Solis, Sofar, Goodwe, etc			
Optional Feature	Heating, Cooling Fan, Active Balancer, Touch Screen, Fire Protection			
Warranty	10 Years (warranty or cycle life, whichever comes first)			

OEM/CUSTOMIZED OPTIONS

 <p>Heating</p>	 <p>Cooling Fan</p>	 <p>Fire Protection</p>
 <p>Touch Screen</p>	 <p>Active Balancer</p>	 <p>Magnetic cover</p>

51.2V WALL/FLOOR-MOUNTED LIFEPO4 SERIES

- BR-OW-LV 11KWH
- BR-OW-LV 15KWH
- BR-OW-LV 16KWH



PRODUCT FEATURES



Advanced LiFePO4 Technology
Lithium iron phosphate(LFP) Battery, longer cycle life, stable performance



Advanced Protection
BasenGreen Smart BMS & Protective Circuit Breaker Reliable protection against electric fault



Multi-language Support
Touch screen, easy to operate, supports multiple languages



Reliable Power
Up to 15 years service life



Flexible Configuration
Support up to 16 units in parallel



APP Monitoring
Real-time monitor from Bluetooth & Wi-Fi

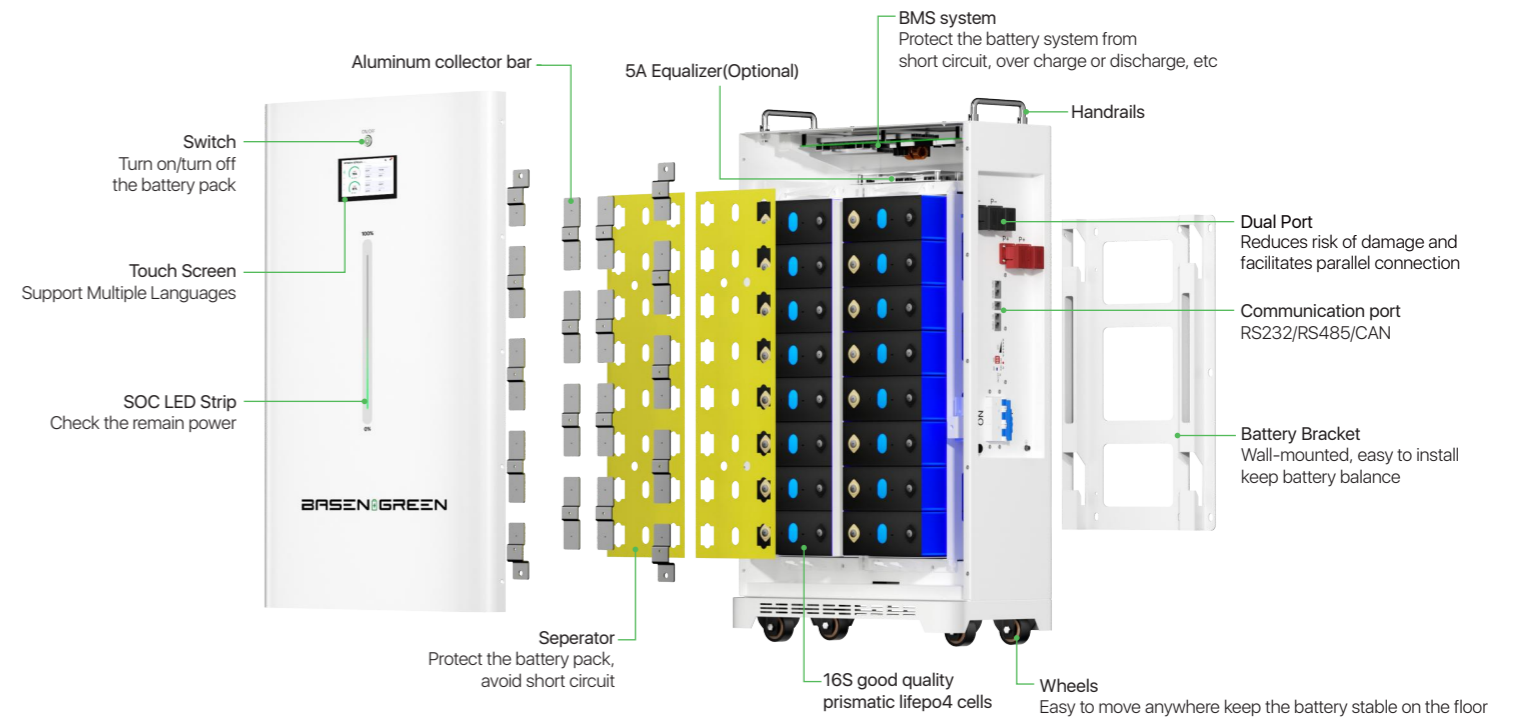

Model	BR-OW-LV 11KWH	BR-OW-LV 15KWH	BR-OW-LV 16KWH
Battery Chemistry	Lithium iron phosphate(LiFePO4)		
Rated Voltage(V)	51.2		
Operating Voltage Range(V)	43.2-57.6		
Charge/Discharge Cut-off Voltage(V)	58.4/43.2		
Capacity(Ah)	230	300	314
Energy(Wh)	11770	15360	16076
Cycle Life	6000 Cycles (@80% DoD, 25°C/0.5C)	8000 Cycles (@80% DoD, 25°C/0.5C)	8000 Cycles (@80% DoD, 25°C/0.5C)
Max. CHG/DSCHG Current(A)	200	200	200
Dimension(L*W*H,mm)	690*500*272	850*500*272	850*500*272
Weight Approximate(kg)	96	126	128
Communication Port	RS485, CAN, RS232		
Parallet Connection	Up to 16 units in parallel		
Protection Level	IP55		
Charge Temperature Range	0°C~60°C		
Discharge Temperature Range	-20°C~60°C(Under 0°C work with reduced capacity)		
Storage Temperature Range	-40°C~55°C @ 60±25% relative humidity		
Inverter Compatibility	DEYE, Victron, Growatt, Solis, Sofar, Goodwe, etc		
Optional Feature	Heating, Cooling Fan, Active Balancer, Touch Screen, Fire Protection		
Warranty	10 Years (warranty or cycle life, whichever comes first)		

51.2V FLOOR-MOUNTED LIFEPO4 SERIES

BR-VT-LV 15KWH

BR-VT-LV 16KWH

BR-VT-LV 32KWH



PRODUCT FEATURES



Advanced LiFePO4 Technology
Lithium iron phosphate(LFP) Battery, longer cycle life, stable performance



Advanced Protection
BasenGreen Smart BMS & Protective Circuit Breaker Reliable protection against electric fault



Multi-language Support
Touch screen, easy to operate, supports multiple languages



Reliable Power
Up to 15 years service life



Flexible Configuration
Support up to 16 units in parallel



APP Monitoring
Real-time monitor from Bluetooth & Wi-Fi

Model	BR-VT-LV 15KWH	BR-VT-LV 16KWH	BR-VT-LV 32KWH
Battery Chemistry	Lithium iron phosphate(LiFePO4)		
Rated Voltage(V)	51.2		
Operating Voltage Range(V)	43.2-57.6		
Charge/Discharge Cut-off Voltage(V)	58.4/43.2		
Capacity(Ah)	300	314	628
Energy(Wh)	15360	16076	32153
Cycle Life	8000 Cycles (@80% DoD, 25°C/0.5C)	8000 Cycles (@80% DoD, 25°C/0.5C)	8000 Cycles (@80% DoD, 25°C/0.5C)
Max. CHG/DSCHG Current(A)	200	200	200
Dimension(L*W*H,mm)	885*500*255	885*500*255	800*420*650
Weight Approximate(kg)	122	123	245
Communication Port	RS485, CAN, RS232		
Parallel Connection	Up to 16 units in parallel		
Protection Level	IP55		
Charge Temperature Range	0°C~60°C		
Discharge Temperature Range	-20°C~60°C(Under 0°C work with reduced capacity)		
Storage Temperature Range	-40°C~55°C @ 60±25% relative humidity		
Inverter Compatibility	DEYE, Victron, Growatt, Solis, Sofar, Goodwe, etc		
Optional Feature	Heating, Cooling Fan, Active Balancer, Touch Screen, Fire Protection		
Warranty	10 Years (warranty or cycle life, whichever comes first)		

25.6V RACK-MOUNTED LIFEPO4 SERIES

BR-RM-LV 2.5KWH(8S)

BR-RM-LV 5.8KWH(8S)

BR-RM-LV 7.6KWH(8S)

BR-RM-LV 8KWH(8S)



PRODUCT FEATURES



Advanced LiFePO4 Technology
Lithium iron phosphate(LFP) Battery, longer cycle life, stable performance



Advanced Protection
BasenGreen Smart BMS & Protective Circuit Breaker Reliable protection against electric fault



Modular Design
Support install with cabinet/rack



Reliable Power
Up to 15 years service life



Flexible Configuration
Support up to 16 units in parallel



APP Monitoring
Real-time monitor from Bluetooth & Wi-Fi

Model	BR-RM-LV 2.5KWH(8S)	BR-RM-LV 5.8KWH(8S)	BR-RM-LV 7.6KWH(8S)	BR-RM-LV 8KWH(8S)
Battery Chemistry	Lithium iron phosphate(LiFePO4)			
Rated Voltage(V)	25.6			
Operating Voltage Range(V)	21.6-28.8			
Charge/Discharge Cut-off Voltage(V)	29.2/21.6			
Capacity(Ah)	100	230	300	314
Energy(Wh)	2560	5888	7680	8038
Cycle Life	6000 Cycles (@80% DoD, 25°C/0.5C)	6000 Cycles (@80% DoD, 25°C/0.5C)	8000 Cycles (@80% DoD, 25°C/0.5C)	8000 Cycles (@80% DoD, 25°C/0.5C)
Max. CHG/DSCHG Current(A)	100	200	200	200
Dimension(L*W*H,mm)	482*330*177	475*400*238	450*470*240	450*470*240
Weight Approximate(kg)	29	46	60	61
Communication Port	RS485, CAN, RS232			
Parallel Connection	Up to 16 units in parallel			
Protection Level	IP55			
Charge Temperature Range	0°C~60°C			
Discharge Temperature Range	-20°C~60°C(Under 0°C work with reduced capacity)			
Storage Temperature Range	-40°C~55°C @ 60±25% relative humidity			
Inverter Compatibility	DEYE, Victron, Growatt, Solis, Sofar, Goodwe, etc			
Optional Feature	Heating, Cooling Fan, Active Balancer, Touch Screen, Fire Protection			
Warranty	10 Years (warranty or cycle life, whichever comes first)			

OEM/CUSTOMIZED OPTIONS



Heating



Cooling Fan



Fire Protection



Touch Screen



Active Balancer



Magnetic cover

51.2V RACK-MOUNTED LIFEPO4 SERIES

BR-RM-LV 5KWH

BR-RM-LV 11KWH

BR-RM-LV 6KWH

BR-RM-LV 15KWH

BR-RM-LV 7.6KWH

BR-RM-LV 16KWH



15KWH

11KWH

6.4KWH

5KWH

PRODUCT FEATURES



Advanced LiFePO4 Technology
Lithium iron phosphate(LFP) Battery, longer cycle life, stable performance



Advanced Protection
BasenGreen Smart BMS & Protective Circuit Breaker Reliable protection against electric fault



Modular Design
Support install with cabinet/rack



Reliable Power
Up to 15 years service life



Flexible Configuration
Support up to 16 units in parallel



APP Monitoring
Real-time monitor from Bluetooth & Wi-Fi

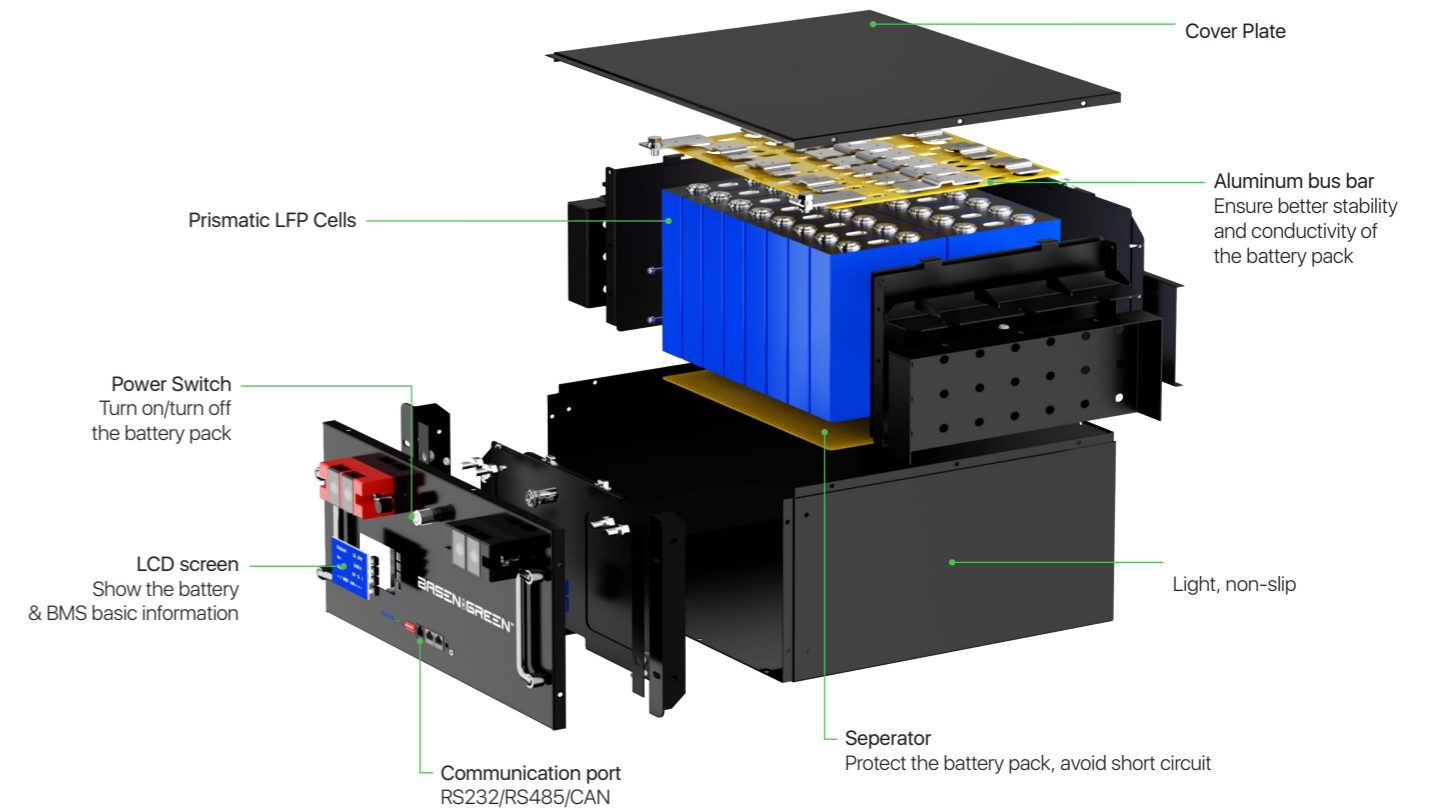

Model	BR-RM-LV 5KWH	BR-RM-LV 6KWH	BR-RM-LV 7.6KWH	BR-RM-LV 11KWH	BR-RM-LV 15KWH	BR-RM-LV 16KWH
Battery Chemistry	Lithium iron phosphate(LiFePO4)					
Rated Voltage(V)	51.2					
Operating Voltage Range(V)	43.2-57.6					
Charge/Discharge Cut-off Voltage(V)	58.4/43.2					
Capacity(Ah)	100	125	150	230	300	314
Energy(Wh)	5120	6144	7680	11770	15360	16076
Cycle Life	6000 Cycles (@80% DoD, 25°C/0.5C)	6000 Cycles (@80% DoD, 25°C/0.5C)	6000 Cycles (@80% DoD, 25°C/0.5C)	6000 Cycles (@80% DoD, 25°C/0.5C)	8000 Cycles (@80% DoD, 25°C/0.5C)	8000 Cycles (@80% DoD, 25°C/0.5C)
Max. CHG/DSCHG Current(A)	100	100	100	200	200	200
Dimension(L*W*H,mm)	482*550*177	475*400*238	482*500*245	480*618*248	475*777*255	475*777*255
Weight Approximate(kg)	46	52	64	88	120	121
Communication Port	RS485, CAN, RS232					
Parallel Connection	Up to 16 units in parallel					
Protection Level	IP55					
Charge Temperature Range	0°C~60°C					
Discharge Temperature Range	-20°C~60°C(Under 0°C work with reduced capacity)					
Storage Temperature Range	-40°C~55°C @ 60±25% relative humidity					
Inverter Compatibility	DEYE, Victron, Growatt, Solis, Sofar, Goodwe, etc					
Optional Feature	Heating, Cooling Fan, Active Balancer, Touch Screen, Fire Protection					
Warranty	10 Years (warranty or cycle life, whichever comes first)					

51.2V PUSH-PULL COOLING MODEL SERIES

BR-PC-LV 15KWH
 BR-PC-LV 16KWH
 BR-PC-LV 32KWH



PRODUCT FEATURES



Advanced LiFePO4 Technology
 Lithium iron phosphate(LFP) Battery,
 longer cycle life, stable performance



Advanced Protection
 BasenGreen Smart BMS & Protective
 Circuit Breaker Reliable protection against
 electric fault



Multi-language Support
 Touch screen, easy to operate,
 supports multiple languages



Reliable Power
 Up to 15 years service life



Flexible Configuration
 Support up to 16 units in parallel



APP Monitoring
 Real-time monitor from Bluetooth & Wi-Fi

Model	BR-PC-LV 15KWH	BR-PC-LV 16KWH	BR-PC-LV 32KWH
Cell Technology	Lithium-iron Phosphate (LiFePO4)		
Nominal Energy	15kWh	16kWh	32kWh
Nominal Voltage	51.2V	51.2V	51.2V
Nominal Capacity	300Ah	314Ah	628Ah
Dimensions(L/W/H)	800*240*645mm	800*240*645mm	800*430*610mm
Weight	112kg	112kg	214kg
Cycle Life	≥10000 Times (80%DoD)	≥8000 Times (80%DoD)	≥8000 Times (80%DoD)
Max Charge Current	200A		
Max. Cont. Charge Current	200A		
Max Discharge Current	200A		
Max. Cont. Discharge Current	200A		
Operating Voltage Range	43.2V - 57.6V		
Charge Cut-Off Voltage	58.4V		
Discharge Cut-Off Voltage	43.2V		
Installation	Indoor		
Scalability	Max. 16 Modules in Parallel		
Protection Rating	IP55		
Display	SOC Status Indicator, LED Indicator		
Communication	RS485, RS232, CAN		
Charge Temperature Range	0°C~60°C		
Discharge Temperature Range	-20°C~60°C (Under 0°C work with reduced capacity)		
Storage Temperature Range	-40°C~55°C @ 60%±25% relative humidity		
Compatible Inverters	SMA, Victron Energy, Deye, Goodwe, Growatt, Sermatec, etc.		
Warranty	10 Years (warranty or cycle life, whichever comes first)		

51.2V Stack LiFePO4 Series

- BR-BOX-5KWH
- BR-BOX-11KWH
- BR-BOX-15KWH
- BR-BOX-16KWH



40KWH/5KWH*8



44KWH/11KWH*4



60KWH/15KWH*4



64KWH/16KWH*4

PRODUCT FEATURES



Advanced LiFePO4 Technology
Lithium iron phosphate(LFP) Battery, longer cycle life, stable performance



Advanced Protection
BasenGreen Smart BMS & Protective Circuit Breaker Reliable protection against electric fault



Multi-language Support
Touch screen, easy to operate, supports multiple languages



Reliable Power
Up to 15 years service life



Flexible Configuration
Support up to 16 units in parallel



APP Monitoring
Real-time monitor from Bluetooth & Wi-Fi

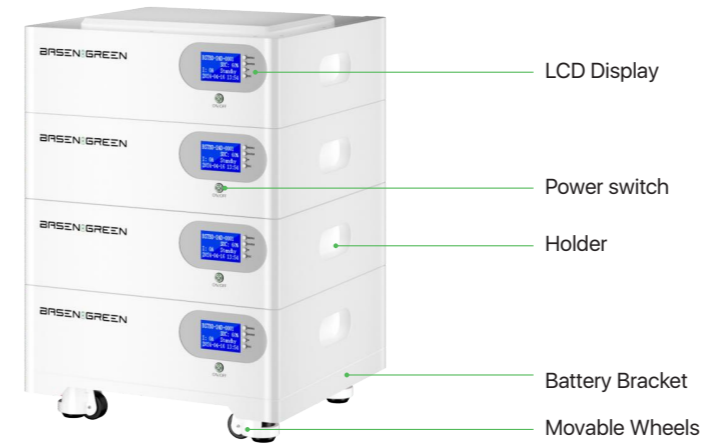

Communication port: RS485/RS232/CAN

Positive terminal

Negative terminal

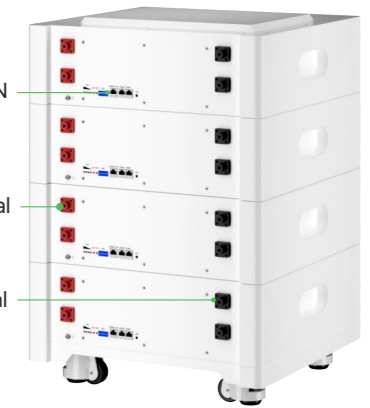

Model	BR-BOX-5KWH	BR-BOX-11KWH	BR-BOX-15KWH	BR-BOX-16KWH
Battery Chemistry	Lithium iron phosphate(LiFePO4)			
Rated Voltage(V)	51.2			
Operating Voltage Range(V)	43.2-57.6			
Charge/Discharge Cut-off Voltage(V)	58.4/43.2			
Capacity(Ah)	100	230	300	314
Energy(Wh)	5120	11770	15360	16076
Cycle Life	6000 Cycles (@80% DoD, 25°C/0.5C)	6000 Cycles (@80% DoD, 25°C/0.5C)	8000 Cycles (@80% DoD, 25°C/0.5C)	8000 Cycles (@80% DoD, 25°C/0.5C)
Max. CHG/DSCHG Current(A)	100	200	200	200
Max. Battery Module Qty In Stack(Units)	8	4	4	4
Dimension(L*W*H,mm)	530*500*170	650*600*250	680*600*250	680*600*250
Weight Approximate(kg)	51	96	119	120
Communication Port	RS485, CAN, RS232			
Parallet Connection	Up to 16 units in parallel			
Protection Level	IP55			
Charge Temperature Range	0°C~60°C			
Discharge Temperature Range	-20°C~60°C(Under 0°C work with reduced capacity)			
Storage Temperature Range	-40°C~55°C @ 60±25% relative humidity			
Inverter Compatibility	DEYE, Victron, Growatt, Solis, Sofar, Goodwe, etc			
Optional Feature	Heating, Cooling Fan, Active Balancer, Touch Screen, Fire Protection			
Warranty	10 Years (warranty or cycle life, whichever comes first)			

HIGH VOLTAGE RACK-MOUNTED LIFEP04 SERIES

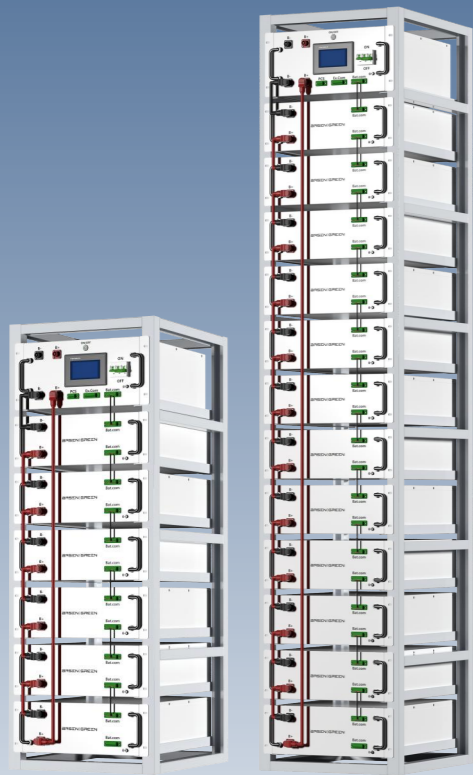

HIGH VOLTAGE STACK LIFEP04 SERIES



C&I ENERGY STORAGE SYSTEM

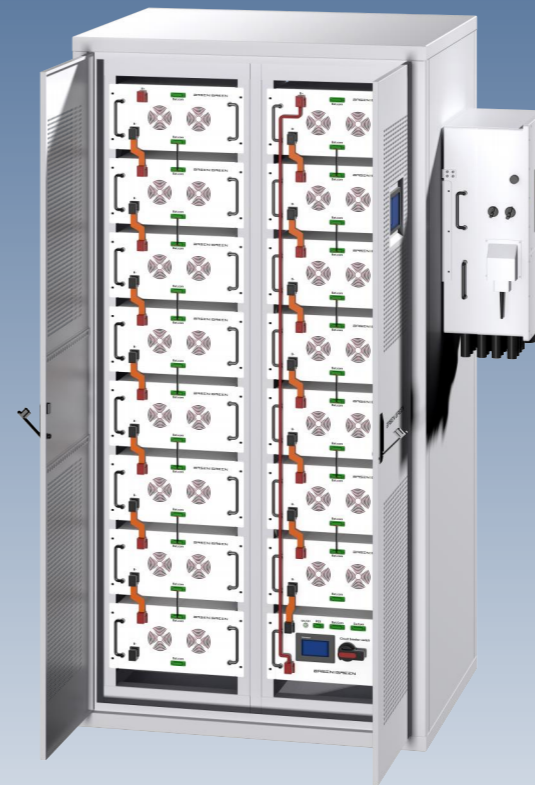

C&I ENERGY STORAGE SYSTEM



HIGH VOLTAGE RACK-MOUNTED LIFEPO4 SERIES

BR-RM-HV-60KWH

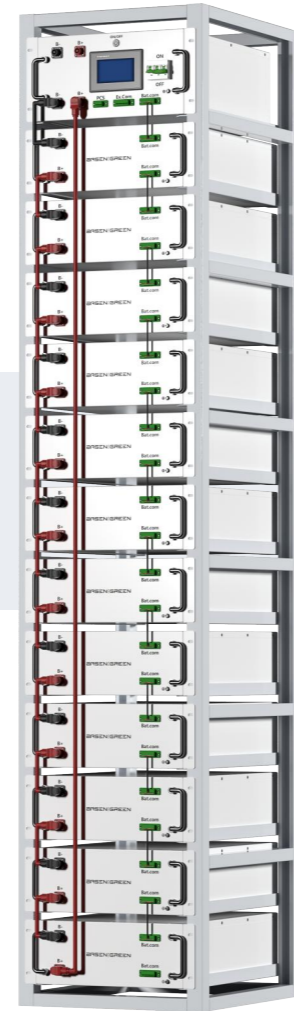
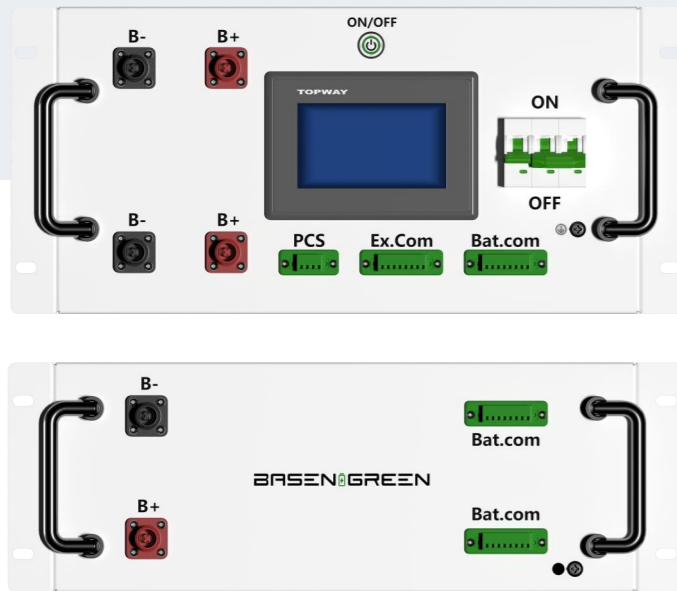

PRODUCT FEATURES



Advanced LiFePO4 Technology
Lithium iron phosphate(LFP) Battery, longer cycle life, stable performance



Intelligent BMS System
Comprehensive BMS with sophisticated monitoring and protection



Modular Design
Scalable from 14/16kWh to multi-MWh configurations



Higher Voltage Architecture
Enables longer string and reduced balance-of-system costs



Compatibility
Compatible with mainstream brand of inverter



Safety Certification
Compliant with rigorous international standards and testing protocols

Model	BR-RM-HV-5KWH
Battery Chemistry	Lithium iron phosphate(LiFePO4)
Connection Style	16S1P
Module Energy(Wh)	5120
Module Nominal Voltage(V)	51.2
Module Capacity(Ah)	100
Operation Voltage Range (V)	44.8-57.6
Recommend Charge Current(A)	50
Recommend Discharge Current(A)	50
Max. Continuous Charge Current(A)	50
Max. Continuous Discharge Current(A)	50
Module Dimension(W*D*H, mm)	440*550*150
Module Weight Approximate(kg)	45
Installation Location	Rack Mounting

Model	BR-RM-HV-20KWH	BR-RM-HV-30KWH	BR-RM-HV-40KWH	BR-RM-HV-50KWH	BR-RM-HV-60KWH
Connection Style	64S1P	96S1P	128S1P	160S1P	192S1P
Battery Module Qty In Series(Units)	4	6	8	10	12
System Nominal Energy(kWh)	20.48	30.72	40.96	50.12	61.44
System Rated Voltage(V)	204.8	307.2	409.6	512	614.4
System Operating Voltage Range(V)	166.4-230.4V	249.6-345.6	332.8-460.8	432-576	518.4-691.2
System Dimension-Rack(L*W*H, mm)	670*580*1160	670*580*1500	670*580*1850	670*580*2200	670*580*2550
System Weight Approximate(kg)	238	340	440	545	638
Cycle Life	6000 cycles(@80%DoD, 25°C/0.5C)				
Recommend Charge Current(A)	50				
Recommend Discharge Current(A)	50				
Max. Continuous Charge Current(A)	50				
Max. Continuous Discharge Current(A)	50				
Communication Port	CAN				
Max.Parallet Quantities(System)	20				
Protection Level	IP20				
Charge Temperature Range	0°C~60°C				
Discharge Temperature Range	-20°C~60°C(Under 0°C work with reduced capacity)				
Storage Temperature Range	-20°C~60°C @ 60±25% relative humidity				
Inverter Compatibility	DEYE, Solis, SMA, Sofar, Goodwe, Invt, Gospower, Sinexcel, etc				
Warranty	10 Years (warranty or cycle life, whichever comes first)				

HIGH VOLTAGE STACK LIFEP04 SERIES

BR-HV-40KWH



PRODUCT FEATURES



Advanced LiFePO4 Technology
Lithium iron phosphate(LFP) Battery, longer cycle life, stable performance



Intelligent BMS System
Comprehensive BMS with sophisticated monitoring and protection



Modular Design
Scalable from 5kWh to multi-MWh configurations



Higher Voltage Architecture
Enables longer string and reduced balance-of-system costs



Compatibility
Compatible with mainstream brand of inverter



Safety Certification
Compliant with rigorous international standards and testing protocols

Model	BR-HV-5KWH
Battery Chemistry	Lithium iron phosphate(LiFePO4)
Connection Style	16S1P
Module Energy(Wh)	5120
Module Nominal Voltage(V)	51.2
Module Capacity(Ah)	100
Operation Voltage Range (V)	44.8-57.6
Recommend Charge Current(A)	50
Recommend Discharge Current(A)	50
Recommend Charge Current(A)	50
Recommend Discharge Current(A)	50
Module Dimension(W*D*H, mm)	530*480*160
Module Weight Approximate(kg)	48
Installation Location	Stack

Model	BR-HV-20KWH	BR-HV-30KWH	BR-HV-40KWH
Connection Style	64S1P	96S1P	128S1P
Battery Module Qty In Series(Units)	4	6	8
System Nominal Energy(kWh)	20.48	30.72	40.96
System Rated Voltage(V)	204.8	307.2	409.6
System Operating Voltage Range(V)	166.4-230.4V	249.6-345.6	332.8-460.8
System Dimension-Rack(L*W*H, mm)	530*480*760	530*480*1240	530*480*1560
System Weight Approximate(kg)	214	310	406
Cycle Life	6000 cycles(@80%DoD, 25°C/0.5C)		
Recommend Charge Current(A)	50		
Recommend Discharge Current(A)	50		
Recommend Charge Current(A)	50		
Recommend Discharge Current(A)	50		
Communication Port	CAN		
Max.Parallet Quantities(System)	20		
Protection Level	IP20		
Charge Temperature Range	0°C~60°C		
Discharge Temperature Range	-20°C~60°C(Under 0°C work with reduced capacity)		
Storage Temperature Range	-20°C~60°C @ 60±25% relative humidity		
Inverter Compatibility	DEYE, Solis, SMA, Sofar, Goodwe, Invt, Gospower, Sinexcel, etc		
Warranty	10 Years (warranty or cycle life, whichever comes first)		

HIGH VOLTAGE STACK LIFEP04 SERIES

BR-HV-84KWH
BR-HV-96KWH



PRODUCT FEATURES



Advanced LiFePO4 Technology
Lithium iron phosphate(LFP) Battery, longer cycle life, stable performance



Intelligent BMS System
Comprehensive BMS with sophisticated monitoring and protection



Modular Design
Scalable from 14/16kWh to multi-MWh configurations



Higher Voltage Architecture
Enables longer string and reduced balance-of-system costs



Compatibility
Compatible with mainstream brand of inverter



Safety Certification
Compliant with rigorous international standards and testing protocols

Model	BR-HV-14KWH		BR-HV-16KWH	
Battery Chemistry	Lithium iron phosphate(LiFePO4)		Lithium iron phosphate(LiFePO4)	
Connection Style	16S1P		16S1P	
Module Energy(Wh)	14330		16076	
Module Nominal Voltage(V)	51.2		51.2	
Module Capacity(Ah)	280		314	
Operation Voltage Range (V)	44.8-57.6		44.8-57.6	
Recommend Charge Current(A)	50		50	
Recommend Discharge Current(A)	50		50	
Max. Continuous Charge Current(A)	100		100	
Max. Continuous Discharge Current(A)	100		100	
Module Dimension(W*D*H, mm)	780*600*245		780*600*245	
Module Weight Approximate(kg)	125		127	
Installation Location	Stack		Stack	
Model	BR-RM-HV-56KWH	BR-HV-84WH	BR-HV-56KWH	BR-HV-96WH
Connection Style	64S1P	96S1P	64S1P	96S1P
Battery Module Qty In Series(Units)	4	6	4	6
System Nominal Energy(kWh)	57.32	85.98	64.28	96.42
System Rated Voltage(V)	204.8	307.2	204.8	307.2
System Operating Voltage Range(V)	166.4-230.4	249.6-345.6	166.4-230.4	249.6-345.6
System Dimension-Rack(L*W*H, mm)	780*600*1360	780*600*1650	780*600*1360	780*600*1650
System Weight Approximate(kg)	532	822	538	828
Cycle Life	8000 Cycles(@80%DoD, 25 C /0.5C)			
Recommend Charge Current(A)	50			
Recommend Discharge Current(A)	50			
Max. Continuous Charge Current(A)	100			
Max. Continuous Discharge Current(A)	100			
Communication Port	CAN			
Max.Parallet Quantities(System)	20			
Protection Level	IP20			
Charge Temperature Range	0°C~60°C			
Discharge Temperature Range	-20°C~60°C(Under 0°C work with reduced capacity)			
Storage Temperature Range	-20°C~60°C @ 60±25% relative humidity			
Inverter Compatibility	DEYE, Solis, SMA, Sofar, Goodwe, Invt, Gospower, Sinexcel, etc			
Warranty	10 Years (warranty or cycle life, whichever comes first)			

COMMERCIAL ENERGY STORAGE SYSTEM



PRODUCT FEATURES



Advanced LiFePO4 Technology
Lithium iron phosphate(LFP) Battery, longer cycle life, stable performance



Intelligent BMS System
Comprehensive BMS with sophisticated monitoring and protection



Plug & Play
Easy Installation and Simple Configuration



Higher Voltage Architecture
Enables longer string and reduced balance-of-system costs



Longer life cycles
Flexibility modular design From 57kWh to 240kWh in each battery cabinet, higher usable energy ratio



Customize Options
Outdoor cabinets, IP67 waterproof

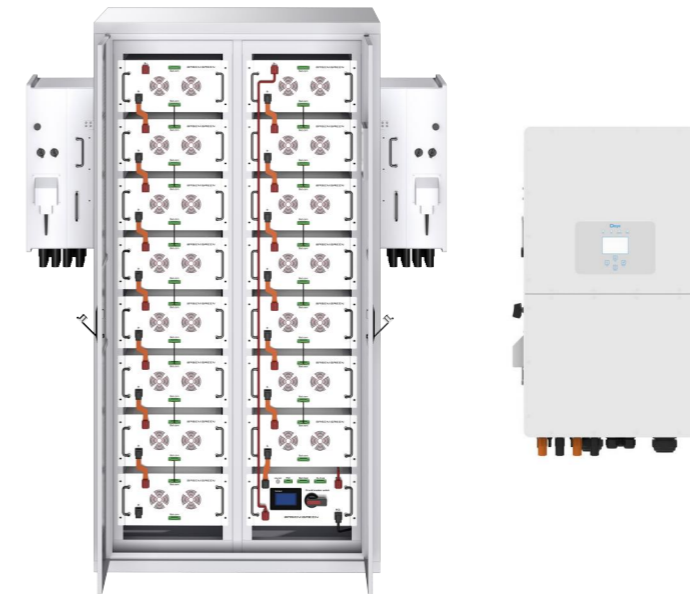

Customized Options

1. Detachable Rack
2. Indoor Cabinet IP21
3. Outdoor Cabinet IP65

Battery Cell		
Rated Voltage	3.2V	3.2V
Nominal Capacity	280Ah	314Ah

Battery Pack		
Combination	1P16S	1P16S
Rated Voltage	51.2V	51.2V
Nominal Capacity	280Ah	314Ah
Weight	140KGS	140KGS

Battery System						
Model	BR-G-57K	BR-G-100K	BR-G-215K	BR-G-64K	BR-G-112K	BR-G-240K
Rated Voltage	204.8V	358.4V	768V	204.8V	358.4V	768V
Rated Capacity	280Ah	280Ah	280Ah	314Ah	314Ah	314Ah
Rated Energy	57344Wh	100352Wh	215040Wh	64307Wh	112537Wh	241152Wh
Dimensions (L*W*H)	1000*680*1600mm	1000*680*2400mm	1000*1250*2400mm	1000*680*1600mm	1000*680*2400mm	1000*1250*2400mm
Combination	1P64S	1P112S	1P240S	1P64S	1P112S	1P240S
Communication mode	CAN	CAN	CAN	CAN	CAN	CAN
Weight	585KGS	995KGS	2000KGS	600KGS	1015KGS	2050KGS
Cycle Life	≥8000 @ 25°C	≥8000 @ 25°C	≥8000 @ 25°C	≥8000 @ 25°C	≥8000 @ 25°C	≥8000 @ 25°C
Discharge Working Temperature Range	20~55°C	20~55°C	20~55°C	20~55°C	20~55°C	20~55°C
Charging Working Temperature Range	0°C~45°C	0°C~45°C	0°C~45°C	0°C~45°C	0°C~45°C	0°C~45°C
Operating voltage range	179~230V	313~403V	672~864V	179~230V	313~403V	672~864V
Cooling	Air Cooling	Air Cooling	Air Cooling	Air Cooling	Air Cooling	Air Cooling
Max Efficiency	≥95%	≥95%	≥95%	≥95%	≥95%	≥95%
Rated Current	100A	100A	100A	100A	100A	100A

Optional Inverter Model	SUN-29.9/30/35K-SG01HP3-EU-BM3 SUN-40/50K-SG01HP3-EU-BM4 SUN-60/70/75/80K-SG02HP3-EU-EM6					
Max. No. of inverters supported in parallel	2					

INDUSTRIAL ENERGY STORAGE SYSTEM



PRODUCT FEATURES



Advanced LiFePO4 Technology
Lithium iron phosphate(LFP) Battery, longer cycle life, stable performance



C&I ESS
240 KWH Large Energy Storage System, higher usable energy ratio



Plug & Play
Easy Installation and Simple Configuration



Higher Voltage Architecture
Enables longer string and reduced balance-of-system costs



Longer life cycles
Flexibility modular design From 57kWh to 240kWh in each battery cabinet, higher usable energy ratio



Customize Options
Outdoor cabinets, IP67 waterproof
Air-cooled, air-conditioned

Model	BR-240K
Battery Specifications	
Cell Capacity	314Ah
Battery Voltage Range	672~864V
Nominal Current	0.5C
System Storage Power	241KWH
AC Specifications (on-grid)	
Nominal Power	100kW
AC Nominal Voltage	400V
Wiring	3P4L+PE
Nominal Frequency	50Hz
AC Mximum Current	145A
Max.number of BESS in paralle	12
AC Specifications (off-grid)	
Nominal Power	100kW
AC Nominal Voltage	400V
Wiring	3P4L+PE
Nominal Frequency	50Hz
AC Mximum Current	145A
Unbalanced Load Capacity	100%
On-grid Switching to Off-grid Time	200ms
Off-grid Switching to On-grid Time	200ms
Max.number of BESS in parallel	5
Photovoltaic Input	
MPPT Voltage Range	200~670V
MPPT channels	Up to three
Input Power	Single channel 50kW
System Specifications	
Dimensions(W*D*H)	1850*1265*2250MM
Weight	2800KG
Air Conditioner Power	3kW (Cooling capacity)
Operation Temperature	-20~50°C
Operation Humidity	0~95%(Non-condensing)
Protection Level	IP65
Noise Level	≤75dB
Altitude	≤3000m
Cooling System	Fan Cooling
Display	Touch screen (optional)
Firefighting	Aerosol/Heptafluoropropane (FM-200)/Perfluoro
EMS Communication	Modbus-TCP/Modbus-RTU
Certification	CE, IEC 62619

OUTDOOR ENERGY STORAGE

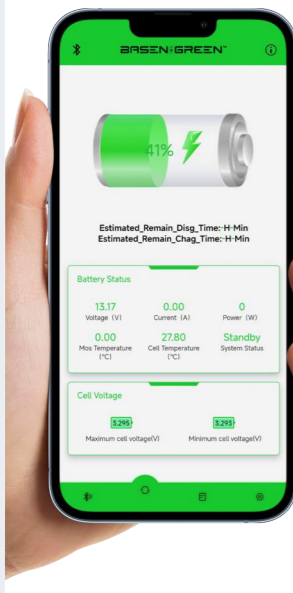

Bluetooth-APP

- SOC Monitor
- Temperature Monitor
- Voltage Monitor
- Current Monitor
- Cycle Monitor
- Cell Monitor

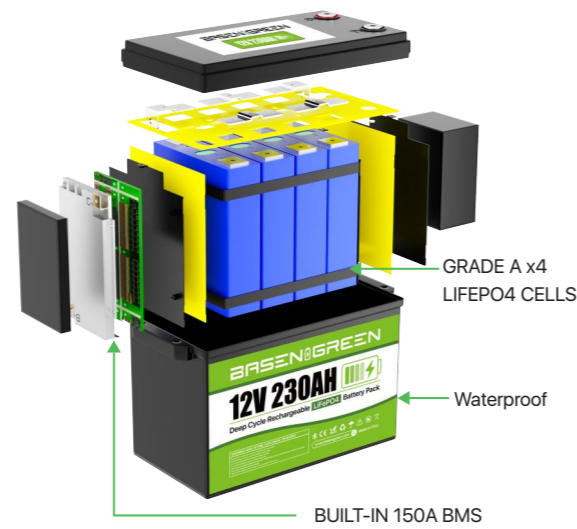

Lead Acid Replacement Battery



Golf Cart Battery



Portable Power Station

12V/24V/51.2V SERIES ALL PURPOSE LITHIUM IRON BATTERIES



Model	BG-12100	BG-12230	BG-12314	BG-12460	BR-12628	BG-24100	BG-24230	BG-24314
Nominal Voltage	12.8V	12.8V	12.8V	12.8V	12.8V	25.6V	25.6V	25.6V
Capacity	100Ah	230Ah	314Ah	460Ah	628Ah	100Ah	230Ah	314Ah
Cycle times	4000 (DoD 80%,25°C)	6000 (DoD 80%,25°C)	8000 (DoD 80%,25°C)	6000 (DoD 80%,25°C)	8000 (DoD 80%,25°C)	4000 (DoD 80%,25°C)	6000 (DoD 80%,25°C)	8000 (DoD 80%,25°C)
Max. Continue Discharge Current	100A	150A	200A	200A	200A	100A	200A	200A
Max. Charging Current	100A	150A	200A	200A	200A	100A	200A	200A
Discharge Cut-off voltage	10.8V	10.8V	10.8V	10.8V	10.8V	21.6V	21.6V	21.6V
Cut-off Charging Voltage	14.6V	14.6V	14.6V	14.6V	14.6V	29.2V	29.2V	29.2V
Size(mm)	340*185*219	384*194*252	384*194*252	522*268*222	635*244*221	522*242*222	522*268*222	635*244*221
Weight	12KG	20KG	26KG	38KG	48KG	20KG	38KG	48KG
Charge Temperature	0°C-55°C							
Discharge Temperature	-20°C-60°C							
Storage Temperature	0°C-45°C							
Protection Class	IP65							
Charging Method	CC-CV							
Terminals	M8(Threaded-hole)							

PRODUCT FEATURES

Bluetooth 5.0

EV Grade A LiFePO4 Cells

Max.4S4P Connection

IP65 WATERPROOF

Low-Temp Cut-Off Protection



10 Years Lifespan

BG-12230
12V 230Ah LiFePO4

Lithium Iron Phosphate
 Deep Cycle Battery

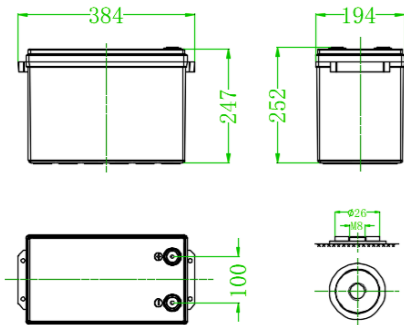

Physical Dimension-mm



- Lighter Weight**
About 40% of the weight of a comparable lead acid battery. Easy to replace lead acid batteries.
- Higher Power**
Delivers twice power of lead acid battery. Higher discharge rate, while maintaining high energy capacity.
- Longer Cycle Life**
Offers up to 20 times longer cycle life and five times longer float and calendar life than lead acid battery.
- Superior Safety**
Lithium Iron Phosphate chemistry eliminates the risk of explosion or combustion due to high impact, overcharging or short circuit.

Specification

Nominal Voltage	12.8V	Max. Continuous Discharge Current	150A
Nominal Capacity	230Ah / 2944Wh	Peak Discharge Current	450A±160A (0.5-1.5S)
BMS	Bluetooth with Smartphone App	Discharge Cut-off Voltage	10V±0.5V
Cycle Life	>6000 cycles @0.5C / 80%DOD	Charge Temperature	0°C~55°C @60±25% Relative Humidity
Months Self Discharge	<3%	Discharge Temperature	-20°C~60°C @60±25% Relative Humidity
Efficiency of Charge	100% @0.5C	Storage Temperature	-20°C~45°C @60±25% Relative Humidity
Efficiency of Discharge	96~99% @0.5C	Protection Class	IP65
Charge Voltage	14.2~14.6V	Approx. Dimensions	384*194*255mm
Charge Mode	0.2C to 14.6V, then change to 0.02C (CC/CV)	Approx. Weight	22kg
Recommended Charge Current	100A	Terminal	M8
Max. Charge Current	150A	Maximum Modules in Series&Parallel	4S4P
Charge Cut-off Voltage	14.6V±0.2V	Optional Features	Heating and Active equalization

12V230AH

BG-12230

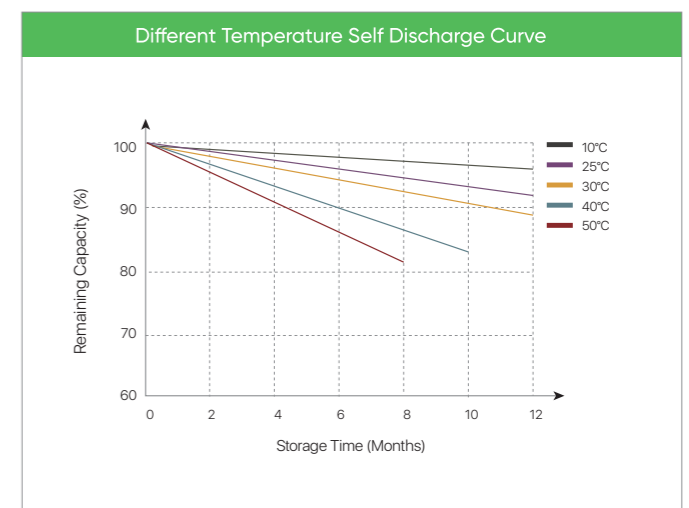
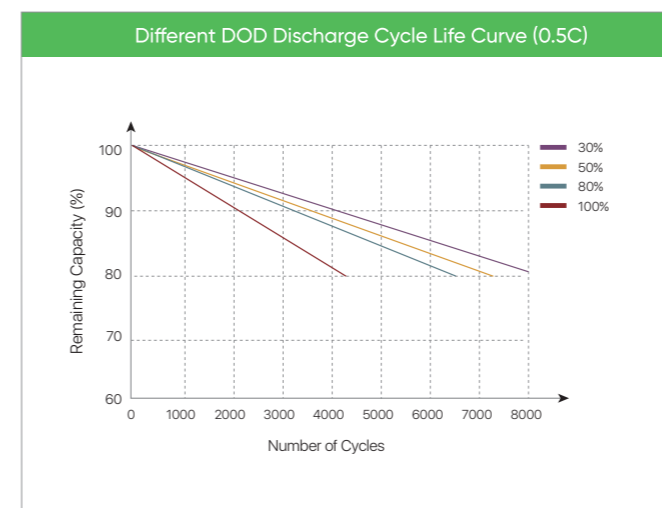
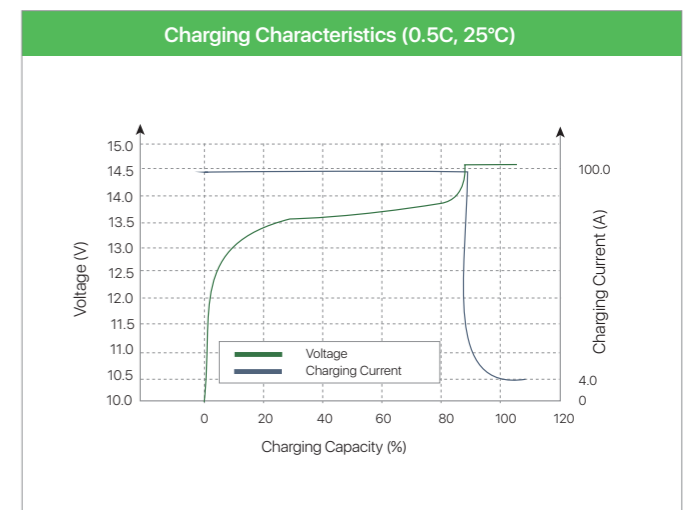
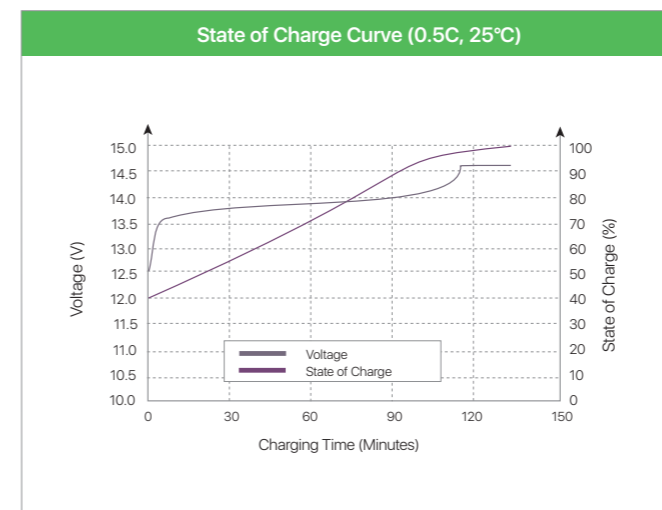
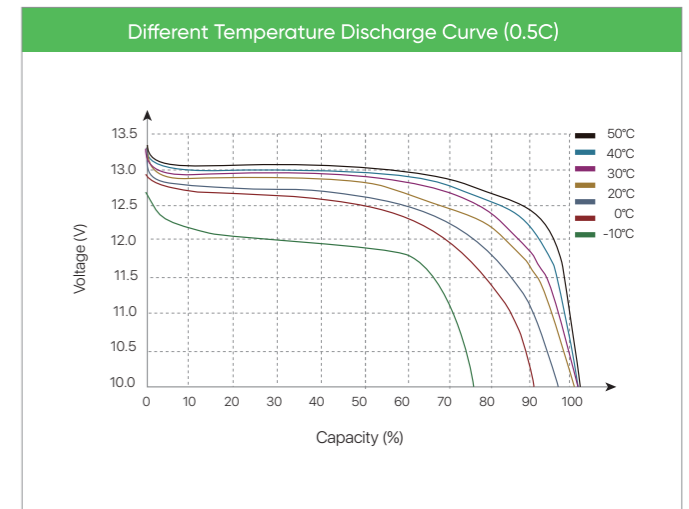
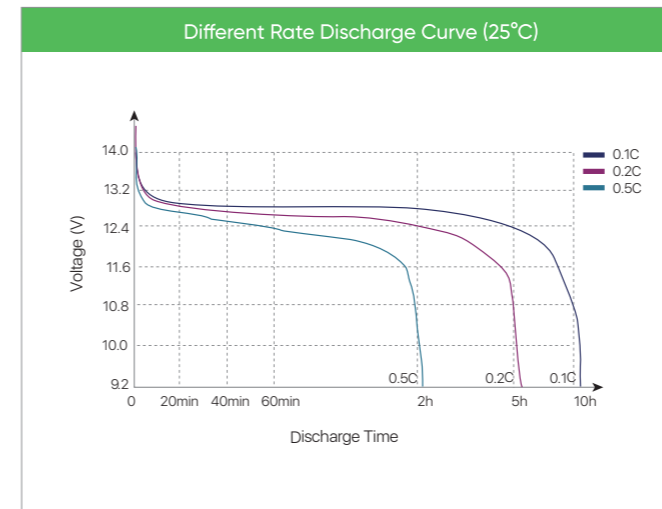

(Note) All above information shall be changed without prior notice, Basen reserves the right to explain and update the latest information.

BG-24230 24V 230Ah ^{LiFePO4}

Lithium Iron Phosphate
Deep Cycle Battery



Physical Dimension-mm

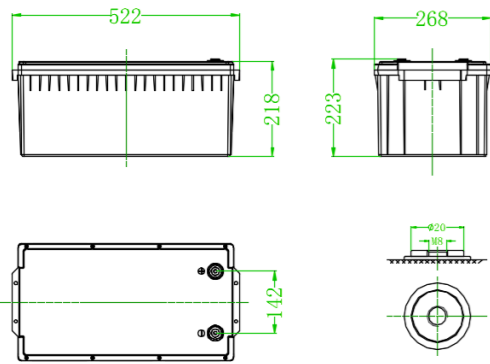

- Lighter Weight**
About 40% of the weight of a comparable lead acid battery.
Easy to replace lead acid batteries.
- Higher Power**
Delivers twice power of lead acid battery.
Higher discharge rate, while maintaining high energy capacity.
- Longer Cycle Life**
Offers up to 20 times longer cycle life and
five times longer float and calendar life than lead acid battery.
- Superior Safety**
Lithium Iron Phosphate chemistry eliminates the risk of explosion
or combustion due to high impact, overcharging or short circuit.

Specification

Nominal Voltage	25.6V	Max. Continuous Discharge Current	200A
Nominal Capacity	230Ah / 5888Wh	Peak Discharge Current	450A±160A (0.5-1.5S)
BMS	Bluetooth with Smartphone App	Discharge Cut-off Voltage	21.6V±0.05V
Cycle Life	>6000 cycles @0.5C / 80%DOD	Charge Temperature	0°C~55°C @60±25% Relative Humidity
Months Self Discharge	<3%	Discharge Temperature	-20°C~60°C @60±25% Relative Humidity
Efficiency of Charge	100% @0.5C	Storage Temperature	-20°C~45°C @60±25% Relative Humidity
Efficiency of Discharge	96~99% @0.5C	Protection Class	IP65
Charge Voltage	28.4~29.2V	Approx. Dimensions	523*269*218mm
Charge Mode	0.2C to 29.2V, then change to 0.02C (CC/CV)	Approx. Weight	40kg
Recommended Charge Current	100A	Terminal	M8
Max. Charge Current	200A	Maximum Modules in Parallel	2S4P
Charge Cut-off Voltage	29.2V±0.2V	Optional Features	Heating and Active equalization

24V230AH

BG-24230

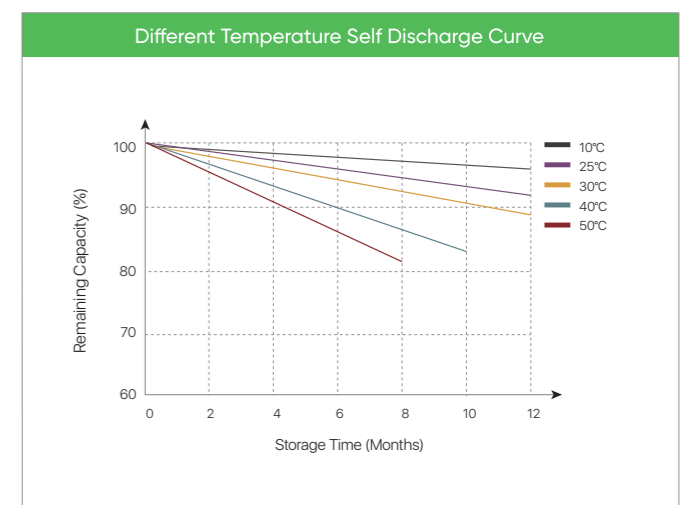
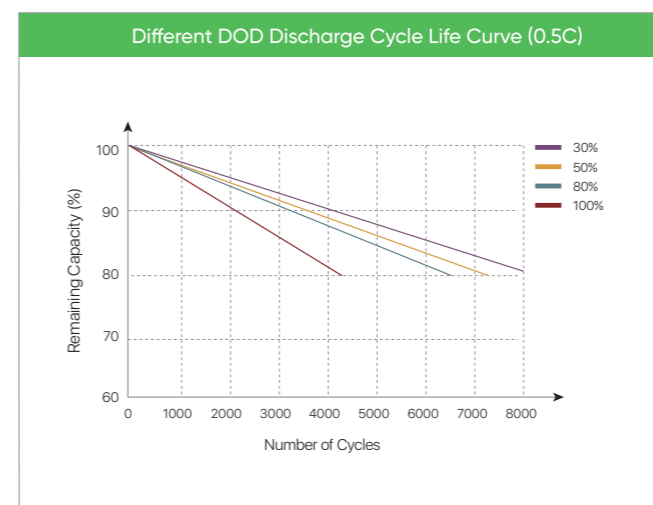
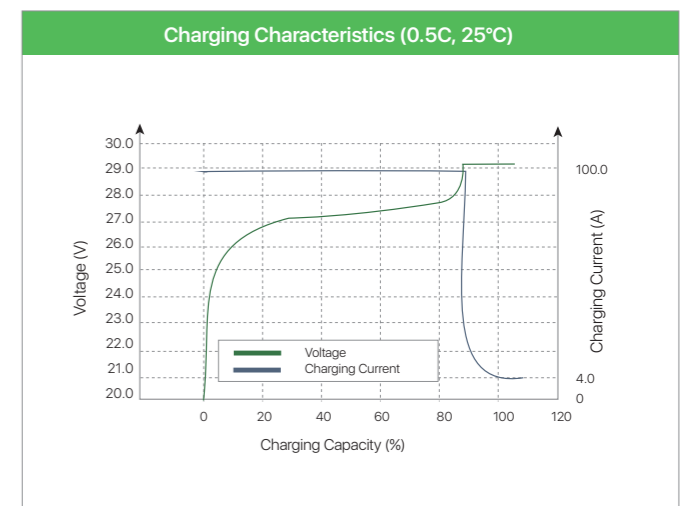
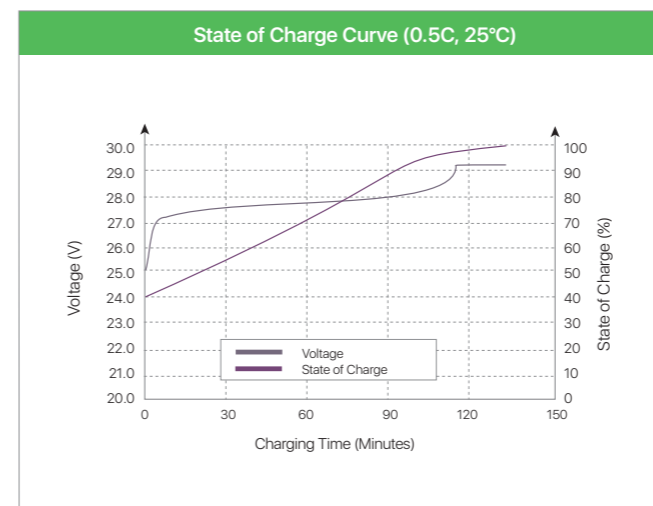
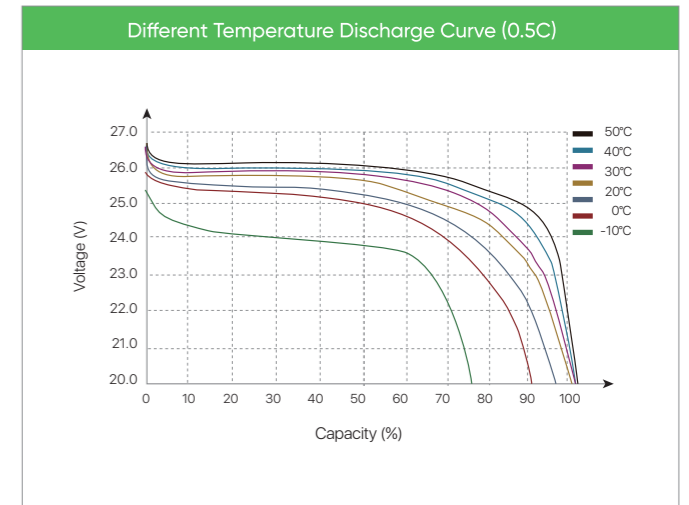
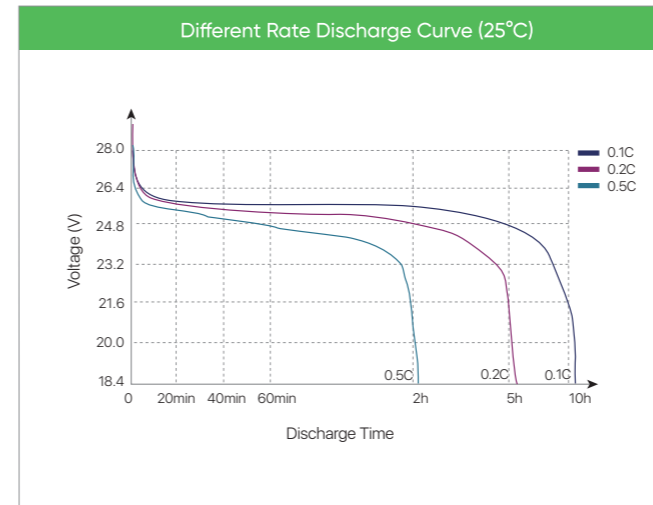

(Note) All above information shall be changed without prior notice, Basen reserves the right to explain and update the latest information.

BG-51105
51.2V 105Ah LiFePO4

Lithium Iron Phosphate
 Deep Cycle Battery



Physical Dimension-mm

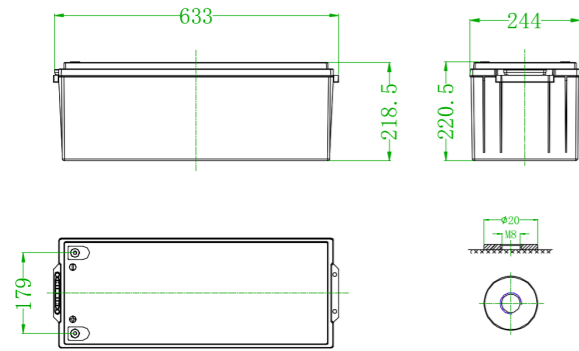

- Lighter Weight**
About 40% of the weight of a comparable lead acid battery. Easy to replace lead acid batteries.
- Higher Power**
Delivers twice power of lead acid battery. Higher discharge rate, while maintaining high energy capacity.
- Longer Cycle Life**
Offers up to 20 times longer cycle life and five times longer float and calendar life than lead acid battery.
- Superior Safety**
Lithium Iron Phosphate chemistry eliminates the risk of explosion or combustion due to high impact, overcharging or short circuit.

Specification

Nominal Voltage	51.2V	Max. Continuous Discharge Current	150A
Nominal Capacity	105Ah / 5376Wh	Peak Discharge Current	450A±160A (0.5-1.5S)
BMS	Bluetooth with Smartphone App	Discharge Cut-off Voltage	43.5V±0.5V
Cycle Life	>5000 cycles @0.5C / 80%DOD	Charge Temperature	0°C~55°C @60±25% Relative Humidity
Months Self Discharge	<3%	Discharge Temperature	-20°C~60°C @60±25% Relative Humidity
Efficiency of Charge	100% @0.5C	Storage Temperature	-20°C~45°C @60±25% Relative Humidity
Efficiency of Discharge	96~99% @0.5C	Protection Class	IP65
Charge Voltage	56.8~58.4V	Approx. Dimensions	633mm*244mm*220.5mm
Charge Mode	0.2C to 14.6V, then change to 0.02C (CC/CV)	Approx. Weight	39kg
Recommended Charge Current	100A	Terminal	M8
Max. Charge Current	150A	Maximum Modules in Parallel	4
Charge Cut-off Voltage	58.4V±0.2V	Optional Features	Heating and Active equalization

51.2V105AH

BG-51105

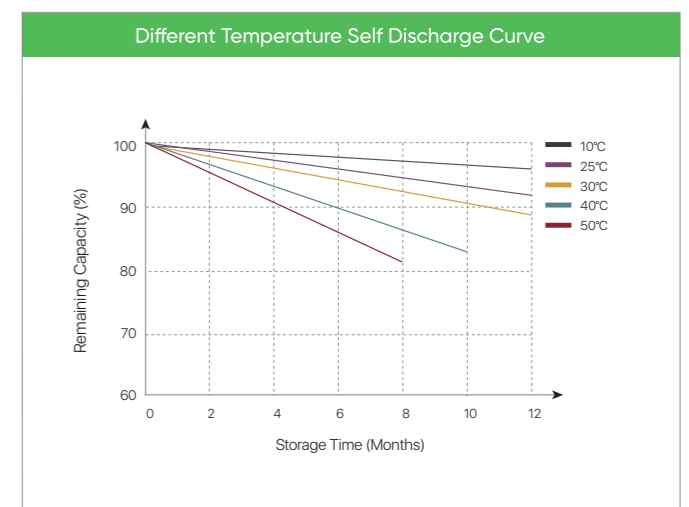
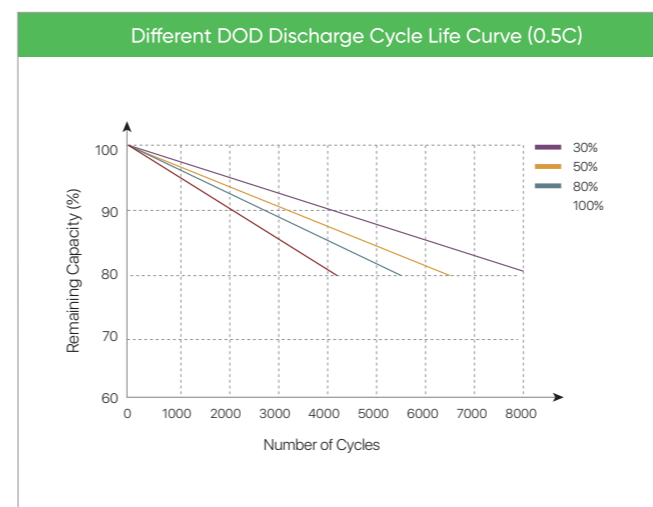
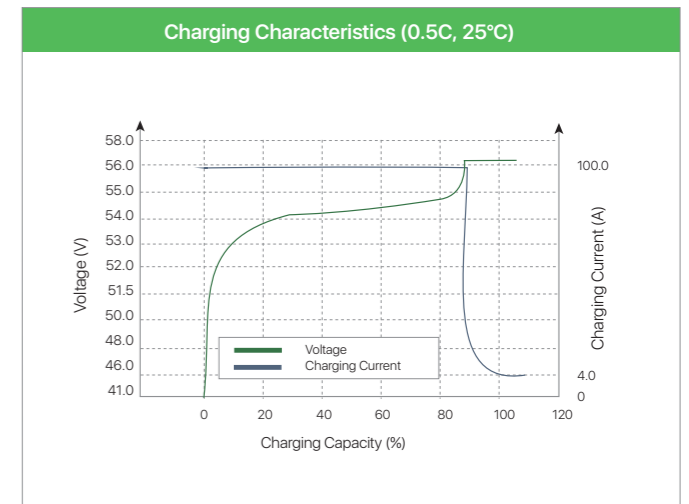
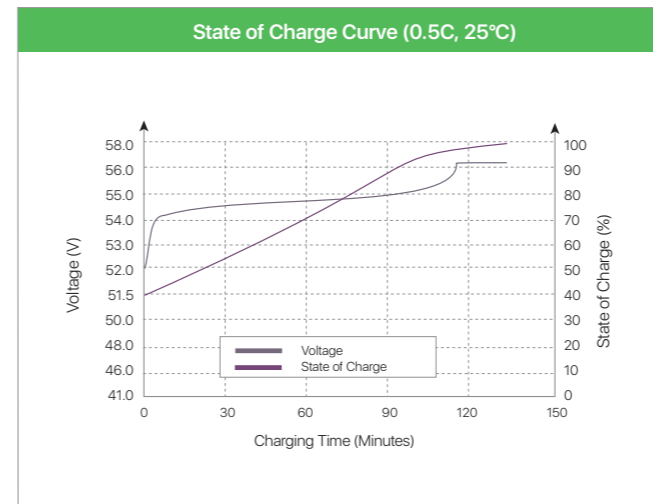
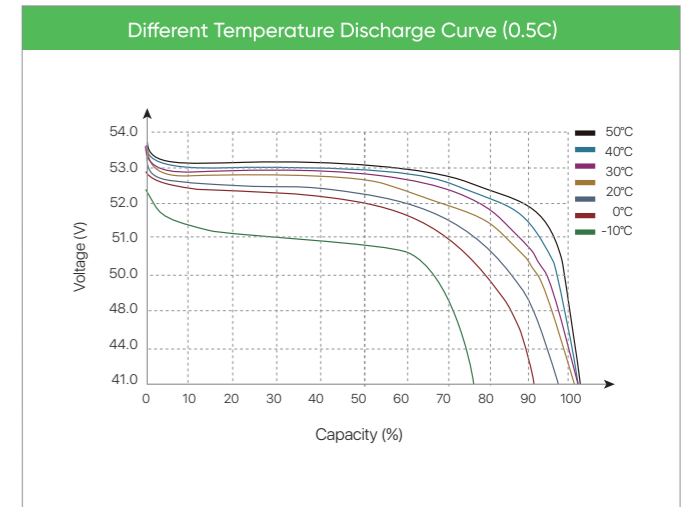
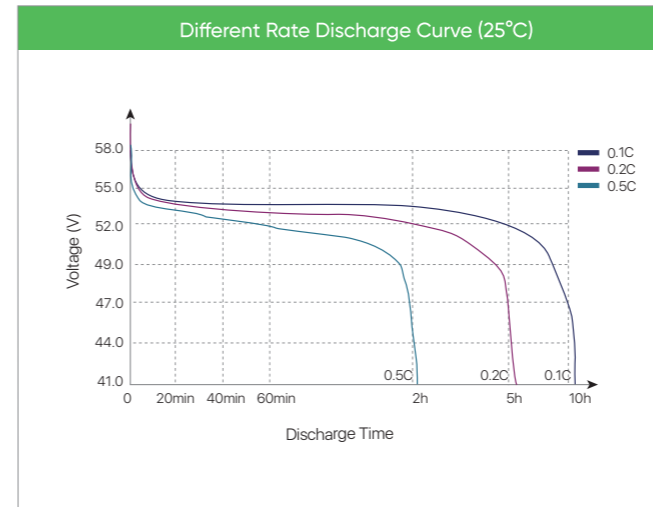

(Note) All above information shall be changed without prior notice, Basen reserves the right to explain and update the latest information.

GOLF CART LIFEPO4 BATTERY SERIES

36V105AH
48V105AH
72V105AH



PRODUCT FEATURES



Protections

Over-Charge/Discharge
Over-Current High
/Low Temperatures Short-Circuiting, Etc



Performance

200A BMS,
larger current support



Flexible configuration

Max. support 4pcs
in parallel connection



Design(optional)

4000+ Cycles
Weight 50% Lighter Than Lead-Acid Battery



Durability

Touch Screen
LiFePO4 Charger



APP

Mobile App To Control
The Battery (Soc) In Real Time.

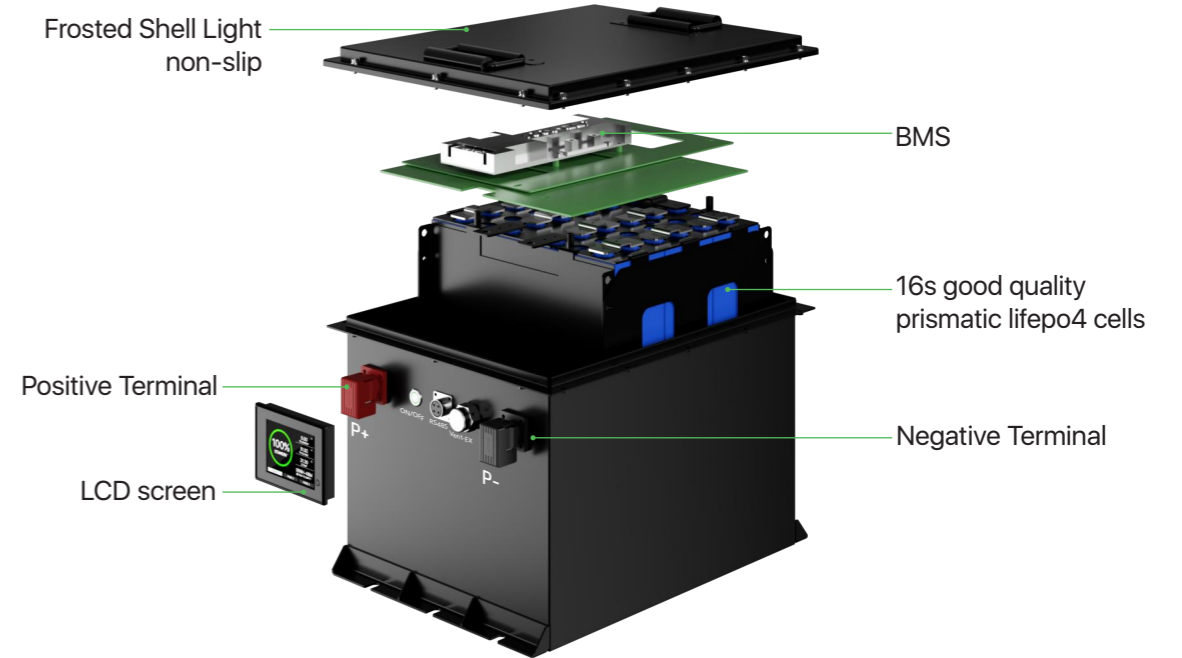

Model	36V105AH	48V105AH	72V105AH
Rated Voltage (V)	38.4V	51.2V	76.8V
Rated Capacity (Ah)	105AH	105AH	105AH
Rated Energy (Wh)	4034WH	5376WH	8064WH
Combination Method	1P12S	1P16S	1P24S
Protection Level	IP65	IP65	IP65
Standard Display Screen	Optional	Optional	Optional
Dimensions (LWH mm)	415*325*265	490*325*265	640*325*265
Net Weight (KG)	42KG	51KG	72KG
Cycle Life	≥4000 @ 25°C	≥4000 @ 25°C	≥4000 @ 25°C
Discharge Operating Temperature Range (°C)	20~55°C	20~55°C	20~55°C
Charge Operating Temperature Range (°C)	0°C~45°C	0°C~45°C	0°C~45°C
Operating Voltage Range (V)	32.4~43.8V	43.2V~58.4V	64.8V~87.6V
Charge Current (A)	100A	100A	100A
Discharge Current (A)	200A	200A	200A

PORTABLE POWER STATION

BR-P-300



PRODUCT FEATURES

CE MSDS UN38.3

Energy-saving
Energy-efficient Zero Standby Power

Cost-effective
Lightweight & Cost-effective 1 Kwh Supply

Efficiency
Fully Charged in 4 Hours Sunlight

Safe and reliable
3-Year Warranty

Common Electrical Devices Reference

- Lamp**
20W/50H
- Fan**
30W/33H
- TV**
100W/10H
- Smartphone**
2942mAh/90Times
- Laptop**
60W/16H
- Car Refrigerator**
60W/16H
- Projector**
100W/10H
- Hair Dryer**
200W/50H
- Radio**
10W/100H
- Pet Feeder**
6W/166H

Model	BR-P-300
Process	Metal Spray Coating
Battery Material	Lithium Iron Phosphate (LiFePO4)
Rated Capacity	1005Wh(314Ah)
Battery Life	8000 Cycles / 80% DoD
DC5521*3	12V/3A (Type B)
USB*2	5V/3A
EPS (Uninterrupted Power Supply)	Supported
Inverter Switching Time (from grid power)	<100ms
Grid Power Switching Time (from inverter)	<100ms
Operating Noise	≤55dB
Operating Humidity	20 ~ 90% RH, no condensation
Storage Temperature / Humidity	-20 ~ +65°C, 10 ~ 95% RH
Weight	9 kg
Size	L294 * W130 * H217 mm
Rated Power	300W
AC Input Voltage Range/Frequency	100-240V, 50/60Hz, eff>88%
PV Input Voltage Range/Maximum Charging Power	12-30V, 350W, eff >90%
Inverter Output Maximum Power/Waveform	Maximum Power 300W / Pure Sine Wave / eff >88%
AC Outlet	Standard (supports Capacitive and Inductive Load)
AC Charging Power	250W
Battery Indicator Lights	5 LEDs
Protection Types	<ul style="list-style-type: none"> • Input Overvoltage Protection • Input Undervoltage Protection • Output Overvoltage Protection • Output Overload Protection • Output Undervoltage Protection • Output Overcurrent Protection <ul style="list-style-type: none"> • Short Circuit Protection • Overtemperature Protection • Battery Overvoltage Protection • Battery Low Voltage Protection • Battery Overcurrent / Short Circuit Protection (Charging) • Battery Overcurrent /Short Circuit Protection (Discharging) • Battery High/Low Temperature Protection

DIY KIT Series

Discover our new DIY kits and easily customize your energy storage solution

12V/24V DIY Kit



48V DIY Kit



LIFEPO4 CELL MODEL LIST & PARAMETERS

Brand	Model	Nominal Voltage (V)	Capacity (Ah)	Standard Cycle (25°C)	Initial IR (1kHz)	Weight (g)	Lengthx WidthxHeight (mm)
EVE	LF50F	3.2	50	1500(0.5C/0.5C)	<2.0m2	1035±100	148×71×131
EVE	LF50K	3.2	32	7000(1C/1C)	<0.7m2	1395±50	135×29×185
EVE	LF100MA	3.2	101	2000(0.5C/0.5C)	<0.5mQ	1920±100	160×50×118
EVE	LF100LA	3.2	102	5000(0.5C/0.5C)	<0.5mΩ	1985±100	160×50×118
EVE	LF105	3.2	105	4000(0.5C/0.5C)	<0.5mΩ	1980±60	130×36×200
EVE	LF125	3.22	125	4000(0.5C/0.5C)	<0.4mΩ	2390±71	200×33×172
EVE	LF150	3.22	150	4000(0.5C/0.5C)	<0.4mΩ	2830±84	200×33×207
EVE	LF160	3.22	160	4000(0.5C/0.5C)	<0.2mΩ	3000±100	173×53×153
EVE	LF173	3.22	173	4000 (0.5C/0.5C)	<0.2mΩ	3190±96	173×41×207
EVE	LF230	3.2	230	4000(0.5C/0.5C)	<0.2mΩ	4140±124	173×53×207
EVE	LF280K	3.2	280	8000(0.5C/0.5C)	<0.2mΩ	5490±300	173×71×207
EVE	LF304	3.2	304	4000(0.5C/0.5C)	<0.1mΩ	5450±164	173×71×207
EVE	MB30	3.2	306	10000(0.5C/0.5C)	<0.1m2	5600±300	173×71×207
EVE	MB31	3.2	314	8000(0.5C/0.5C)	<0.1mΩ	5600±300	173×71×207
EVE	MB56	3.2	628	8000(0.5C/0.5C)	<0.2mΩ	10700±300	72×352×207
CATL	LF280	3.2	280	6000(1C/1C)	<0.17mΩ	5340±300	173×71×207
CATL	LF302	3.2	302	6000(1C/1C)	<0.18mQ	5510	173×71×207
CATL	LF306	3.2	306	10000(1C/1C)	<0.18mQ	5510	173×71×207
CATL	LF320	3.2	320	6000(1C/1C)	<0.18mΩ	5510	173×71×207
REPT	LF280	3.2	280	6000(0.5C/1C)	<0.3mΩ	5400±150	173×71×207
REPT	LF320	3.2	320	8000(0.5C/0.5C)	<0.3mΩ	5780±200	173×71×207
Envision	LF315	3.2	315	10000(0.5C/0.5C)	<0.2mΩ	5650±300	173×71×207
Cornex	LF314	3.2	314	6000(0.5C/0.5C)	<0.2mΩ	5700±100	174×71×207
Lishen	LF314	3.2	314	8000(0.5C/0.5C)	<0.2mΩ	5600±300	173×71×207
Hithium	LF280	3.2	280	10000(0.5C/0.5C)	<0.2mΩ	5430±200	173×71×207
Hithium	LF314	3.2	314	8000 (0.5C/0.5C)	<0.2mΩ	5430±200	173×71×207

COMPANY HONORS

Our commitment to excellence is demonstrated through a range of industry-recognized certifications. This section highlights the key credentials we have earned, reflecting our adherence to the highest standards and our dedication to delivering top-quality solutions to our clients.

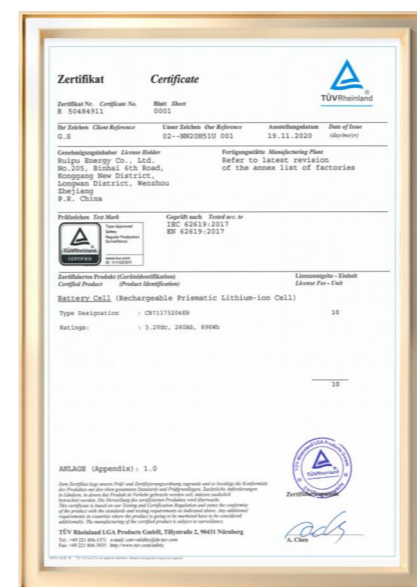
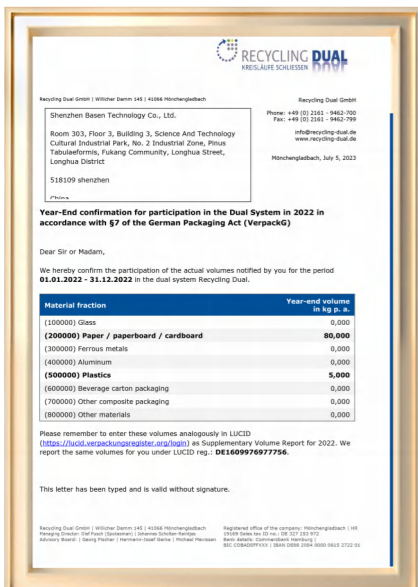
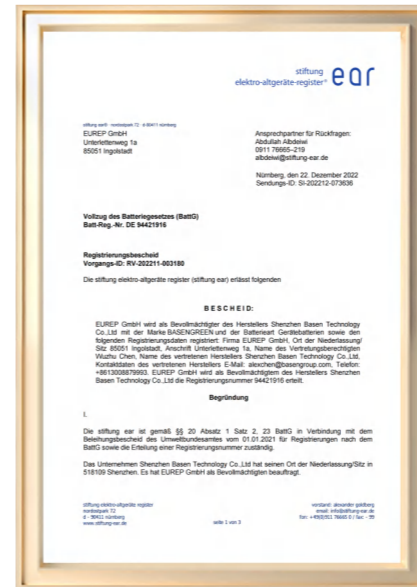

PROJECTS

📍 Netherlands



📍 Denmark



📍 Denmark



📍 Iraq



📍 Iraq



📍 Romania



📍 Bulgaria



📍 Italy



📍 Netherlands



📍 Netherlands



📍 Italy



📍 Denmark

